

2004-2018 Volvo Vehicle

Installation Guide [for HRN-CE10A2 and HRN-CM24Y1 harnesses]

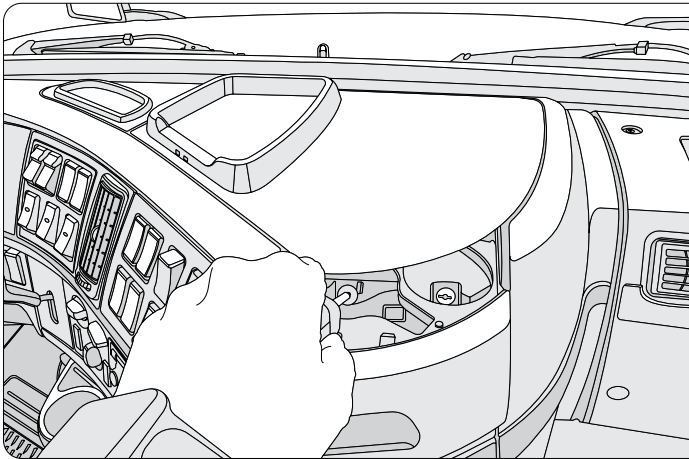

Step 1: Remove the fuse box panel – located under the center console between the driver and passenger seat. Use the two T25 torx head screws to remove the panel.

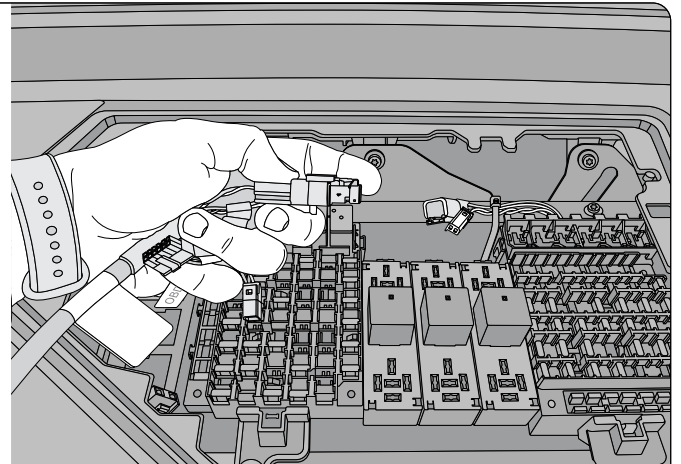
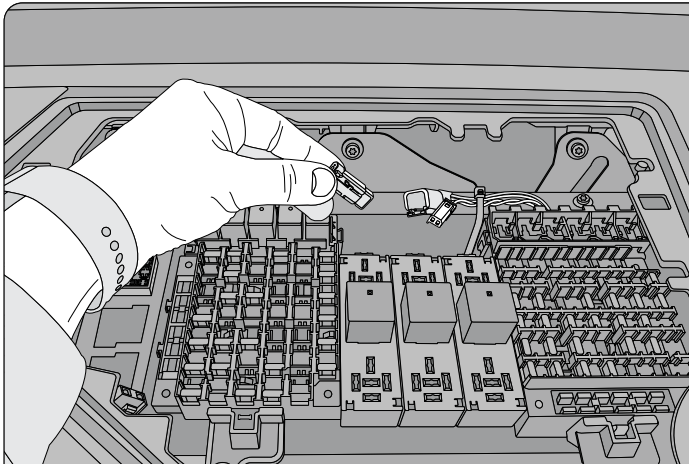

Step 2: Locate the OEM 2 pin gray connector (J1939) with the End of Line resistor. Remove the End of Line resistor from the vehicle connector, then immediately insert the End of Line resistor into the mating connector of the **HRN-CE10A2** harness.

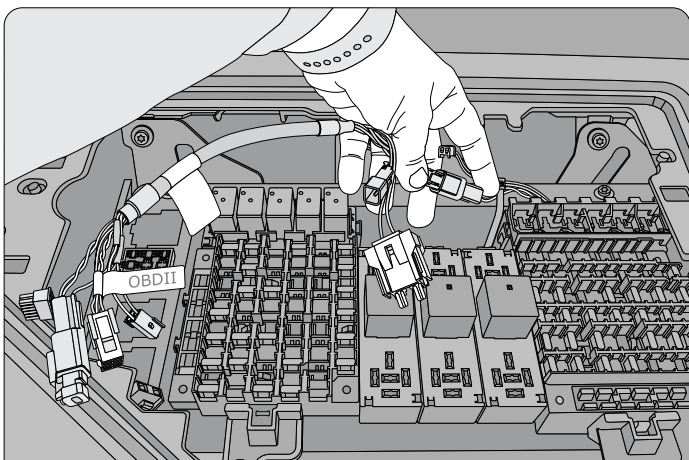

Step 3: Connect the **HRN-CE10A2** to the vehicle side where the End of Line resistor was removed from.

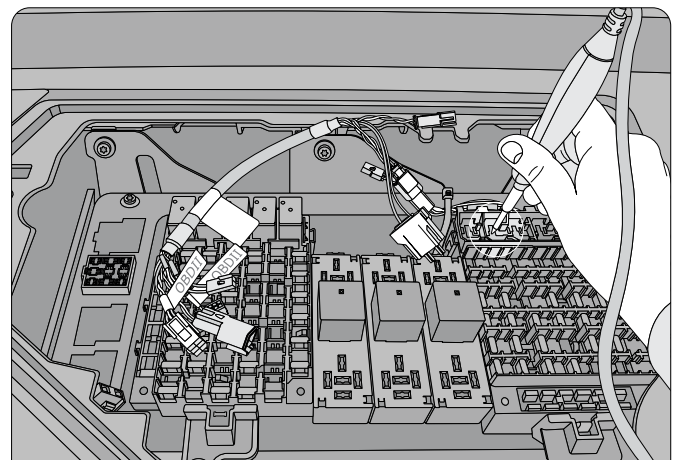

Step 4: Plug in the **HRN-CE10A2** 2-pin power connector into the tested and verified power slot.

Step 5: Plug the **HRN-CE10A2** 2 pin into the power slot that tested for constant power.

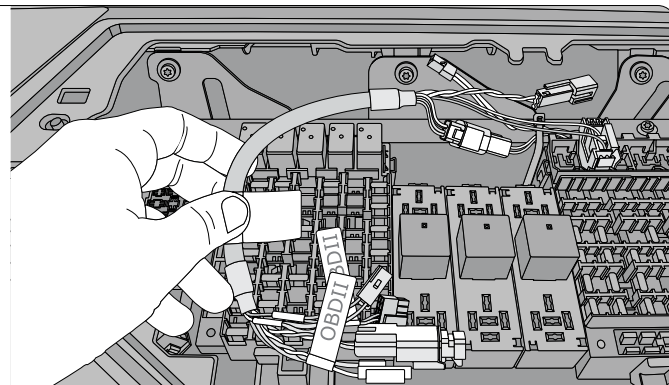

! IMPORTANT: Ensure the harness is plugged in the correct orientation – the constant power must align with the red wire and the ground must align with the black wire on the **HRN-CE10A2** harness.

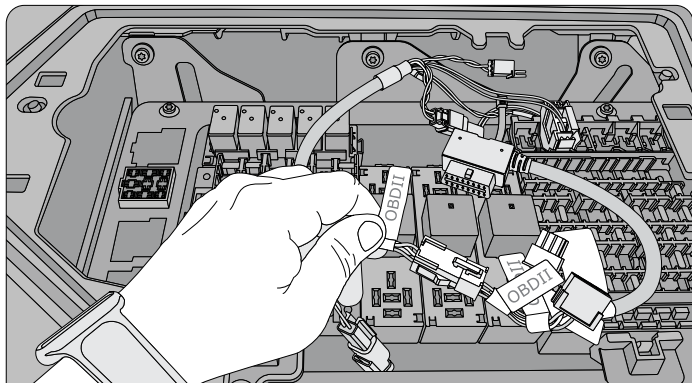

Step 6: Connect the 6-pin white Molex connector of the **HRN-CM24Y1** harness labeled OBDII to the 6-pin white Molex connector on the **HRN-CE10A2** harness labeled OBDII.

! IMPORTANT: Use a zip-tie to securely mount the GO device. The GO device must remain stationary to ensure accurate feedback and data collection.

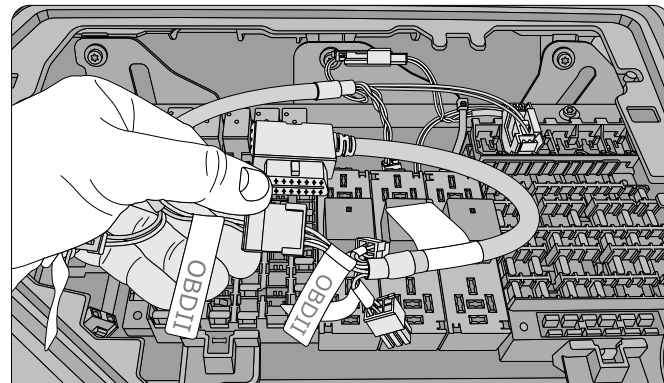

! NOTE: For Volvo vehicle models from 2004 to 2007 – where the gray 2-pin J1939 connector is not available – use the black 2-pin J1587 connector. The black 2-pin J1587 connector may not have an End of Line resistor. Also, connect the OBD II-labelled 12-pin white Molex connector instead of the OBD II-labelled 6-pin white Molex connector.

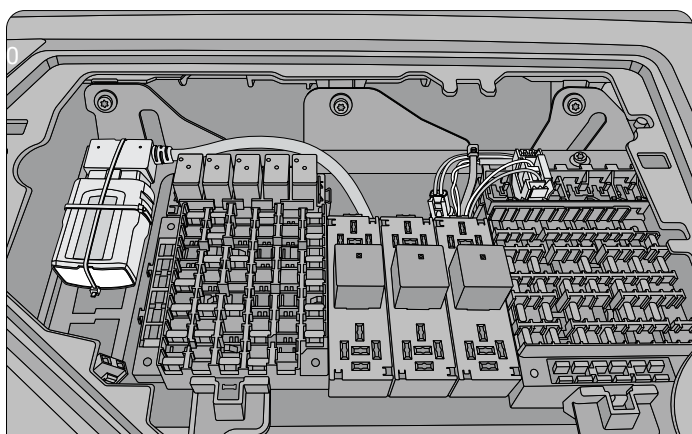

Step 7: Use zip ties to secure the **HRN-CE10A2** and **HRN-CM24Y1** harnesses then place the wires inside and replace the panel cover.

Step 8: Navigate to installmygps.com to verify that the device is communicating. In the space provided, enter your name, the company name, and the GO device serial number – found at the bottom of the device. Click **Log Install**.

After you click **Log Install**, the web page displays the current communication status of the device – in **GREEN** or **RED** text. If the device is communicating, the status is displayed in **GREEN** text. If the device is not communicating, the status is displayed in **RED** text.

***NOTE:** if the device is not communicating, please verify the GO device is installed correctly and try again.

2019-2020 Volvo Vehicles

Installation Guide [for HRN-CS14S2, HRN-CM24Y1, & HRN-CE10A2 harnesses]

Introduction

This installation guide provides information on how to install the HRN-CE10A2 and HRN-CM24Y1 harnesses into applicable 2019 to 2021 Volvo vehicle models.

Requirements

The following tools and materials are required to perform the installation:

- One (1) spade terminal 16 - 18awg (length 15.5mm x width 2.85mm x thickness 0.8mm)
- One (1) ring terminal 16 - 18awg (3/8" diameter)
- Crimping pliers
- Torx T-25

How to Install

Before installing, determining the manufacture date of the Volvo vehicle – found on the VIN in the driver's door jamb. If the Volvo manufacture date is after September 30, 2019, use the **HRN-CS14S2** harness. For installation instructions, visit this link: <https://gtb.page.link/ePYm>. To install the HRN-CE10A2 into applicable 2019 to 2021 Volvo vehicle models, follow the steps below:

Step 1: Remove the fuse box panel – located in the center of the dash. Pry the cover from the side close to the windshield. Do not use the tabs to open the panel as they may break.

NOTE: To install the **HRN-CM24Y1** harness with the **HRN-CE10A2** harness, **HRN-CE10A2** requires modifications.

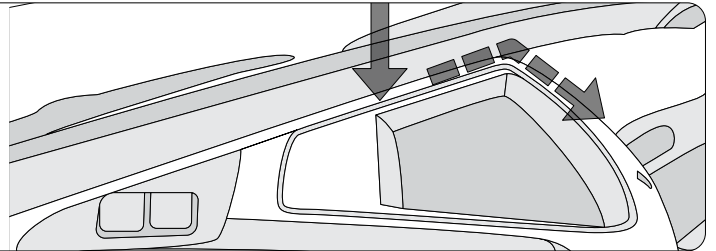

Step 2 a): Follow the **HRN-CS14S2** harness Installation Instructions if the RP-1226 14-pin connector is available. The RP-1226 14-pin connector is located near the Fuse Distribution Center. If following this installation skip to step 13.

Step 2 b): Some Volvo vehicles may not have a RP-1226 14-pin connector. In this case, use the **HRN-CM24Y1** and **HRN-CE10A2** harnesses. To install the **HRN-CM24Y1** harness with the **HRN-CE10A2** harness, please follow the steps below:

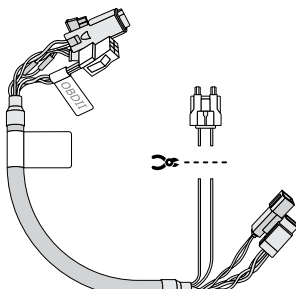
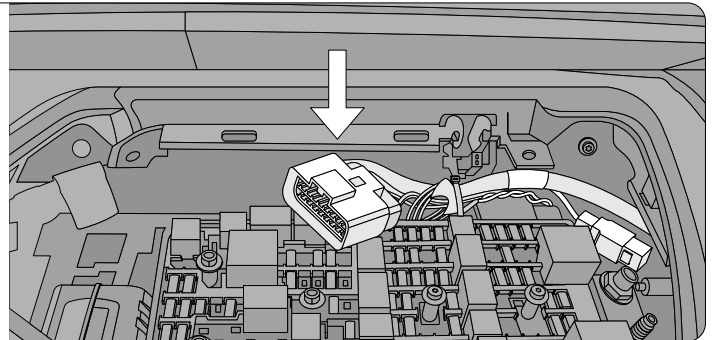

Step 3: Cut off the white spade power connector from the **HRN-CE10A2** harness.

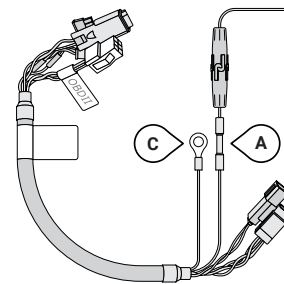

Step 4: Connect the fuse-holder set to the red power cable A.

Step 5: Connect the spade terminal onto the end of the red fused wire B and add the ring terminal for the back ground wire C.

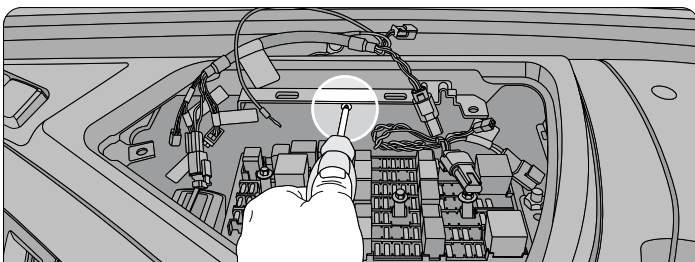

Step 6: Locate and remove the T-25 grounding screw.

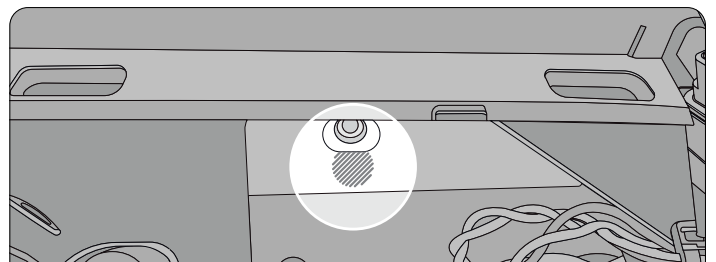

Step 7: Scrape away a sufficient amount of paint.

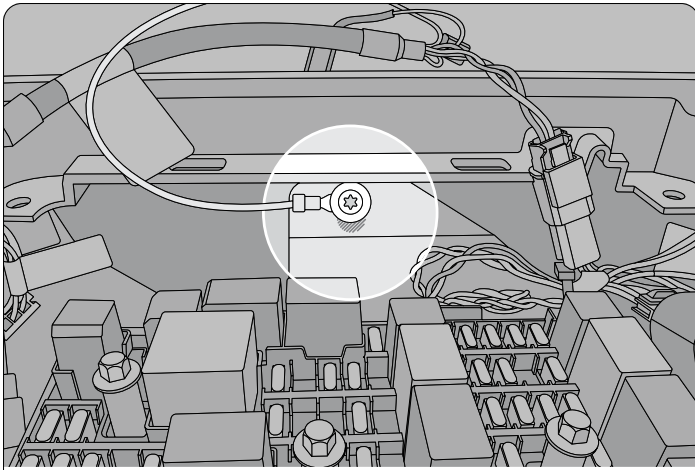

Step 8: Attach the grounding ring terminal and reinstall the ground screw.

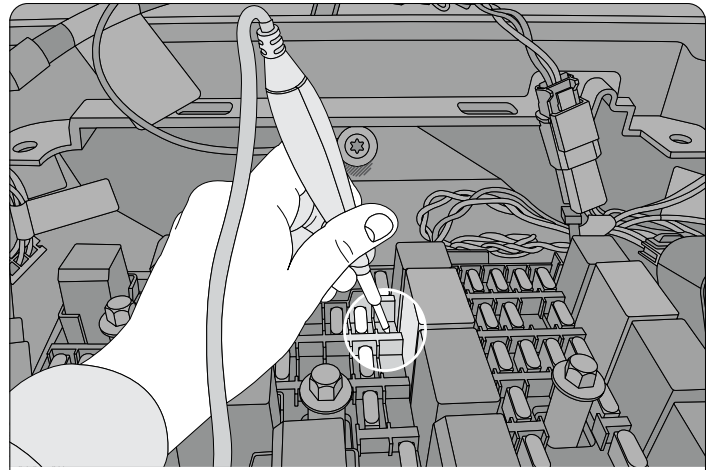

Step 9: Locate an empty or spare fuse slot, and test which side of the fuse holder provides 12 volts constantly. Try to use fuse slot #71, if available.

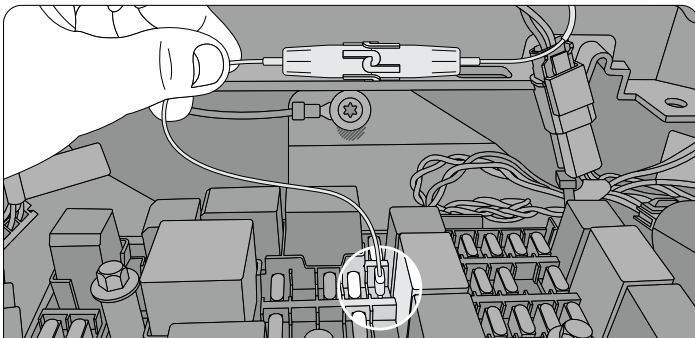

Step 10: Insert the fused spade terminal into the fuse holder side that provides 12 volts constantly.

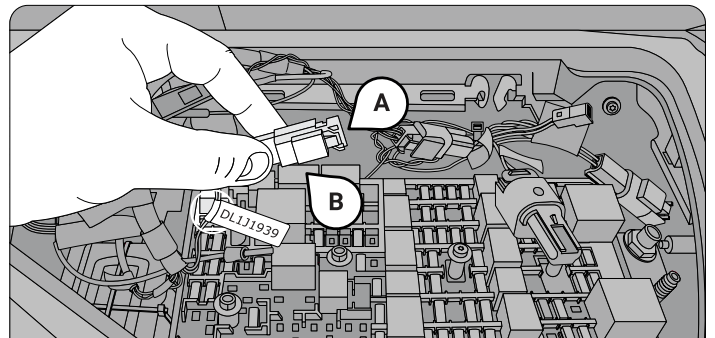

Step 11: Locate the OEM gray 2-pin Deutsch connector (DTM04) with label DL1J1939. Where EOL resistor is present, remove the EOL resistor A from receptacle B.

! IMPORTANT: Multiple gray 2-pin connectors exist. You must use the one labeled DL1J1939, as more data is sent through this port.

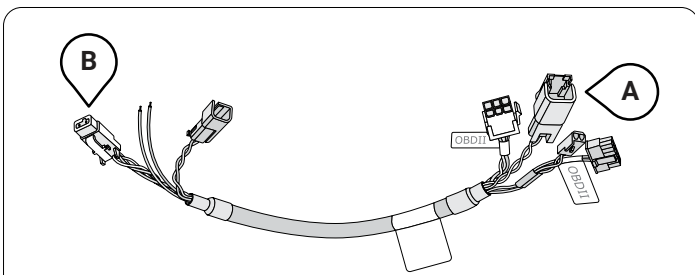

Step 12: Insert the gray Y connector of the HRN-CE10A2 harness and connect the components labeled A and B (i.e. A to A and B to B) — as indicated in the image above and in step 4.

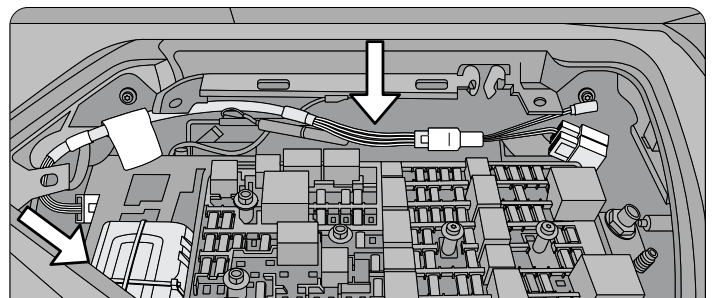

Step 13: Secure the GO device and harnesses with zip ties.

Step 14: Navigate to installmygps.com to verify that the device is communicating. In the space provided, enter your name, the company name, and the GO device serial number — found at the bottom of the device. Click **Log Install**.

After you click **Log Install**, the web page displays the current communication status of the device — in **GREEN** or **RED** text. If the device is communicating, the status is displayed in **GREEN** text. If the device is not communicating, the status is displayed in **RED** text.

***NOTE:** if the device is not communicating, please verify the GO device is installed correctly and try again.